

# PRODUCT SHEET

## Description:

Rail Handle 4507, Aluminum, cc 128mm, 15,5x152mm, Anodized

## Item number:

17.02.012-1

Units	Box	Carton	HS Code	Barcode
Pcs.	70	420	7616991099	 5704866459594

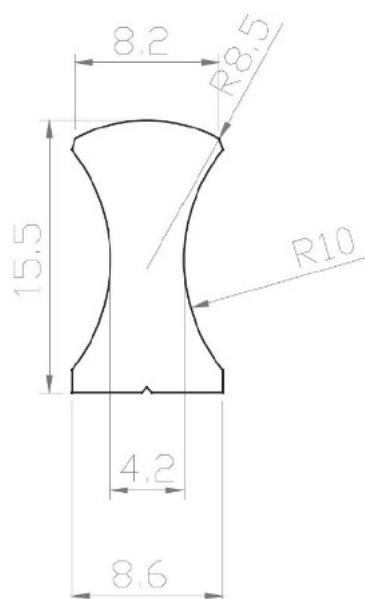

### SISO A/S

Mileparken 11  
DK-2740 Skovlunde  
Denmark  
VAT: DK 24786013

Phone +45 45 830 900

[www.siso.dk](http://www.siso.dk)  
[siso@siso.dk](mailto:siso@siso.dk)

Danske Bank  
Nytorv Branch  
Copenhagen  
SWIFT: DABADKKK

Account no.  
4180 3112 112936  
IBAN Account  
DK7230003112112936